

SurePress L-6534VW UV inkjet digital label press

Take high quality label printing further, faster



EPSON[®]
EXCEED YOUR VISION

High print speeds with exceptional print quality

The SurePress L-6534VW is a premium quality UV inkjet digital label press, designed for high productivity and outstanding finish at print speeds up to 50 meters per minute.

Designed by Epson, the L-6534VW ensures the high print quality you demand is delivered at the speed you need, enabling you to meet diverse customer requirements. New to the SurePress L-6534VW, 'high-speed mode' offers high production output at 50m/min. 'Standard mode' operates at an output speed of 30m/min for high quality, and for the widest colour gamut, there's the 15m/min 'high density mode'. The press also offers high opacity ink plus a 'reverse white mode' which enables white ink to be printed on-top of colours.

The press is highly versatile and with built-in reliability and stability functions, it ensures consistent, high quality results, time-after-time.

The innovative drum platen and UV pinning system ensure a consistently outstanding finish across a range of substrates, in all print modes. The drum platen holds substrates in place as it moves past the various printheads, achieving accurate colour-to-colour registration and enhancing quality. The UV pinning system ensures ink droplets don't spread as they cure, achieving sharp lines and smooth gradations.



Liquors



Industrial Products



Pharmaceutical



Household Products



Novelty



Food/Beverages



Cosmetics



Window Graphics/POP



Consistent colour on repeated print jobs.

A gloss or matte finish can be printed selectively or overall with digital varnish.

UV LED pinning controls the spread of ink dots to achieve half tones, smooth vignettes and pin-sharp detail and text.

Enhanced versatility and quality with extra capabilities

Whatever the job, Epson's label press delivers premium print quality and added value thanks to durable inks, UV pinning and an innovative drum platen.

Drum Platen

The drum platen is a highly accurate web feeding technology. It holds the substrate tightly to prevent meandering and skewing of the web. The substrate is held to the drum as it passes all the printhead colours, to provide excellent colour to colour registration.

The drum platen ensures the gap between the printhead and substrate is kept very small (0.7mm), enabling accurate ink placement, crisp text and fine lines.

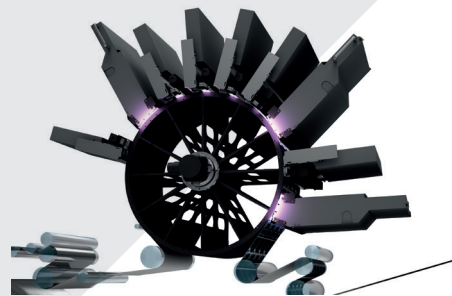

UV pinning on all colours

UV light is applied immediately after each colour is printed. This allows the PrecisionCore head to apply perfectly round drops in their correct positions. The UV pinning prevents ink drops from spreading or deforming as ink is cured before absorption into substrates, enabling the reproduction of vivid colour, smooth gradations and sharp, detailed text. This achieves the wide and accurate colour gamut brand owners require.

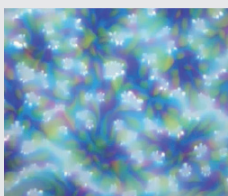
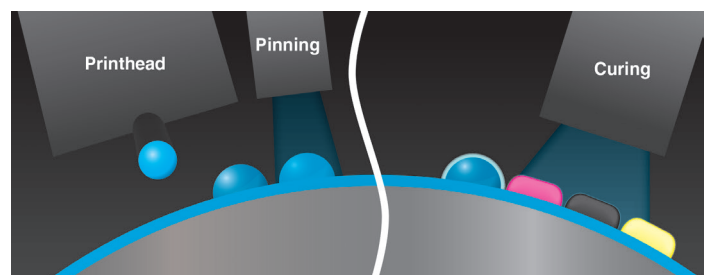

Without pinning

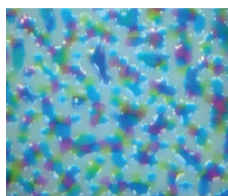

With pinning

Digital Varnish

The innovative digital varnish allows a gloss or matte finish to be printed selectively or overall. The different finishes are achieved by changing the way in which the digital varnish is applied. This capability gives brand owners the option to design different effects and tactile finishes on labels, expanding the versatility of your offering and enabling you to maximise revenue from unlocked opportunities.



Gloss



Matte



Spot varnish

High-opacity ink

The single pass high-opacity white ink provides an ideal base layer for printing vivid colours on clear or metalised substrates. The bright white ink also reproduces opaque fine text and lines.



Wide gamut

Epson UV ink contains a high concentration of pigment particles and along with the LED UV pinning enables wide gamut and vivid colours.

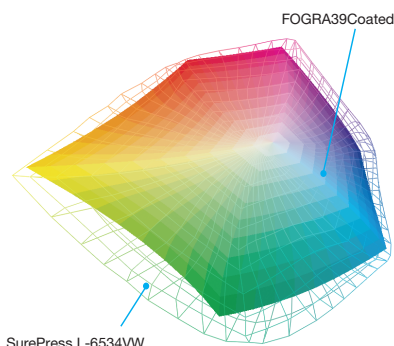

Consistency without compromise

The SurePress L-6534VW features a range of market-leading, Epson-designed technology, ensuring high quality is not compromised across repeated jobs.

Variable Ink Droplet Technology

Epson's reliable PrecisionCore printhead delivers high productivity through single-pass printing with up to 600x1200dpi. The Variable Sized Droplet technology enables beautiful gradation and grey scale using droplets as small as 3.2pl.

The Epson-designed, innovative PrecisionCore printheads consistently fire uniform ink droplets using accurate circular nozzles, enabling exact drop placement for razor sharp definition. Ink spreading is minimised with the assistance of UV pinning across the wide colour gamut. Offer your customers definition and precision, with the SurePress L-6534VW.

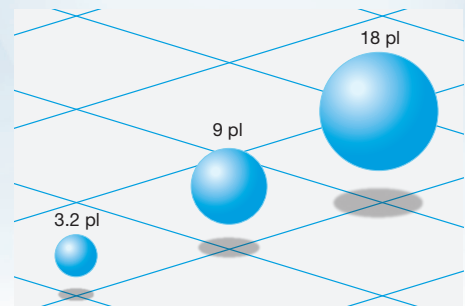

Stable Operation and Intelligent Automation

Unique to Epson, Nozzle Verification Technology (NVT) automatically checks if a nozzle is firing and initiates a cleaning cycle, if necessary. To minimise downtime and keep printing throughout each shift without operator intervention. NVT monitors nozzle status automatically by applying voltage to piezo elements and detecting malfunctions in milliseconds. All nozzles are checked after cleaning and before printing.

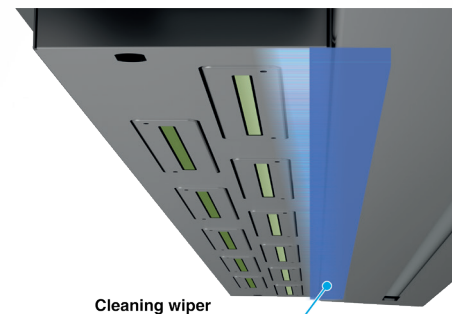

Food Contact Material Compliance

Epson SurePress inks¹ are compliant with the Food Contact Materials regulation (EC No. 1935/2004)². In addition, the inks comply with the safety approved substances listed in the Swiss Ordinance on Materials and Articles in Contact with Food (RS 817.023.21)³ for food packing inks. The production of ink uses a hygiene process control (GMP)⁴, which is similar to those used for food production. In accordance with PIM regulations, Epson inks will not migrate beyond the limit to the food side through the packaging film substrate⁵.

Highly durable ink

Labels printed with Epson UV ink have passed BS5609⁶ and UL969⁷.



Versatile and adaptable processes

The SurePress L-6534VW offers full-colour variable data printing and supports a wide range of substrates for various applications. The corona treater, web cleaner, ioniser, and an additional UV lamp are fitted as standard.

The low temperature UV LED lamps enable printing on heat sensitive substrates such as PE and shrink films.

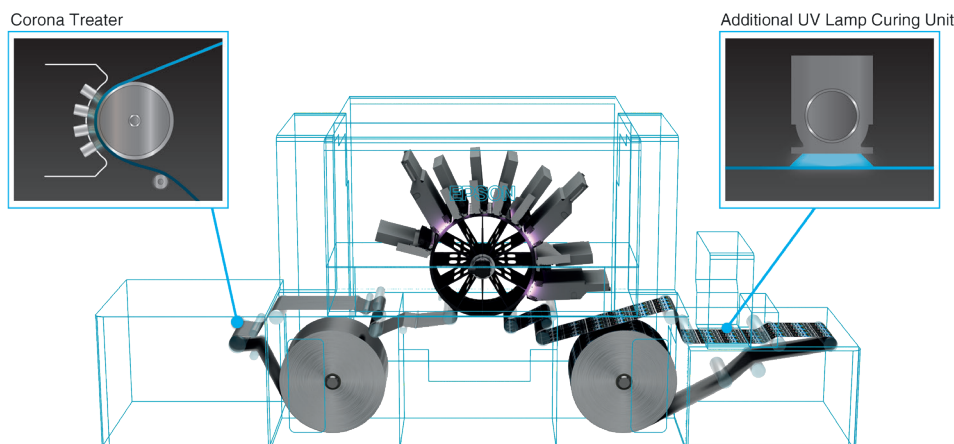

Customer support by remote monitoring system

24/7 remote diagnostics, analysis and operational status monitoring is available to support your business and ensure continuity and productivity across multiple shifts.

Model		SurePress L-6534VW
Print	Print Technology	PrecisionCore linehead inkjet technology
	Maximum Print Resolution	600 x 1200 dpi
	Gradation Process	Variable-Sized Droplet Technology
	Maximum Image Size	330mm x 1000mm
Ink	Ink Type	UV Curable Inks
	Ink Cartridges	Black, Cyan, Magenta, Yellow, Digital Varnish, While, Storage liquid
Print Speed	Productivity Mode	50m/min
	Standard Mode	30m/min
	High Density Mode	15m/min
	Reverse White Mode	7.6m/min
Substrate	Substrate Width	80mm to 340mm
	Substrate Type	Adhesive paper, adhesive film, single-layer paper, and single-layer film
	Substrate Thickness	80 to 320 microns
	Unwinder Capacity	600mm diameter / 100kg weight / 1000m length
Dimensions	Dimensions (W)	4250mm x 2050mm x 2280mm, (included Corona Treater and Additional UV Lamp Curing Unit)
Weight	Weight	Approx. 2,632kg (included Corona Treater and Additional UV Lamp Curing Unit)
	Temperature	20 - 28degC
Environment	Humidity	RH 35 - 55%, Non-condensing required
	Space For Operation	5.5m x 4.8m x 2.8m (W x D x H)
Electric Supply	Main Unit	AC 200V +/- 10% (3 phases 3 lines + protective earthing) 30 A
	Corona Treater	AC 200 - 240V +/- 10% (Single phase + protective earthing) 15A
	Additional UV Lamp	AC 200 - 240V +/- 10% (Single phase + protective earthing) 40A
Exhaust	Main Unit	35-45m ³ /min Ø250mm
	Corona Treater	5m ³ /min or more Ø100mm
	Additional UV Lamp	10-15m ³ /min Ø200mm, 150mm
Compressed Air	Compressed Air	0.5 - 1.0Mpa
Network	Network	10BASE-T/100BASE-T/1000BASE-T

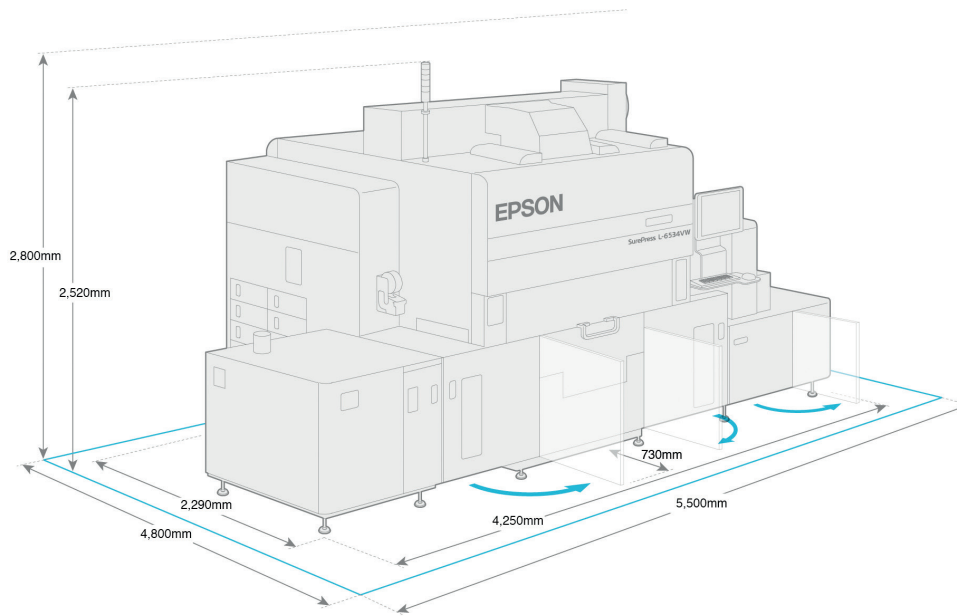

1 Not all SurePress ink comply with FCM Regulations

2 Commission Regulation (EC) No 1935/2004 is the framework legislation for FCMs. The purpose of the Regulation is to ensure the effective functioning of the internal market for materials and articles intended to come into contact directly or indirectly with food and to secure a high level of protection of human health and the interests of consumers. The L-6534VW inks are not intended for direct food contact printing. The safety compliance judgment for the finished product is the responsibility of the final manufacturer, as is based on the customers' packaging form.

3 Swiss Ordinance (RS 817.023.21 Annex 10)

4 Good Manufacturing Practice (EC No. 2023/2006)

5 Plastic Implementation Measure (EU No. 10/2011). Based on the packaging form conditions assumed by Epson

6 BS5609 approved. Internationally recognised specification for printed labels, especially for marine use. It is a requirement for drum labels that need international maritime dangerous goods certification. Lightfastness equates to Blue Wool scale 6.

7 UL969 and CSA Certified. The standard for Marking and Labelling systems. It refers to self-adhesive labels that are used for permanent product identification; typically name plates, for appliance equipment, that include rating information, instructions or schematics.

For further information please contact your local Epson office or visit www.epson.eu/contact-us

Algeria +213 770 938 617 Austria 01 253 49 78 333 Belgium +32 (0)2 792 04 47 Czech +420 246 037 281 Denmark 44 50 85 85 Ethiopia +254700760366
 Finland 0201 552 091 France 09 74 75 04 04 (Cost of local call, operator charges may apply) Germany +49 (0) 2159/92 79 500 Greece (0030) 211 198 62 12
 Hungary 06800 147 83 Ireland 01 436 7742 Israel (+972)-3-5751833 Italy 02-660321 10 (0,12 €/min) Kenya +254 207 904 566 Luxembourg +352 27860692
 Middle East +9714 2677638 Morocco +212 520 134 040 Netherlands +31 (0)20 708 5099 Norway +47 67 11 37 00 Poland +48 22 295 37 25 (0,16 zł/min)
 Portugal 707 222 111 Romania 0040 214025024 Russia (095) 777-03-55 Slovakia +421 232 786 882 Southern Africa +27 (0) 10 109 5320 Spain 93 582 15 00
 Sweden +46 8 5051 3701 (Mobilsamtal – 0,99 kr/min, Lokala samtal – 0,30 kr/min, Utlandssamtal – 0,89 kr/min) Switzerland 022 592 7923
 Tanzania +255 080 011 1014 Tunisia +216 9811 5564 Turkey (0212) 3360303 Uganda +256 205 491 148 United Kingdom 0871 42 37766
 (+10p per minute plus network extras) West Africa +2349046648285

Trademarks and registered trademarks are the property of Seiko Epson Corporation or their respective owners.
 Product information is subject to change without prior notice.

EPSON®