

High quality, reliable printing



SHARE ELIXIR
The subtle taste of SHARE's flavoured Elixir is the result of carefully selected ingredients. We infuse the subtle flavours into the water for a cleaner, crisper, more balanced and refined taste.
Made with our secret blend of ethically sourced flavours.
Printed by Epson SurePress www.epson.eu/surepress

SHARE ELIXIR
The subtle taste of SHARE's flavoured Elixir is the result of carefully selected ingredients. We infuse the subtle flavours into the water for a cleaner, crisper, more balanced and refined taste.
Made with our secret blend of ethically sourced flavours.
Printed by Epson SurePress www.epson.eu/surepress



Greater productivity with exceptional print quality

The SurePress L-4733A/AW Inkjet Digital Label Press is designed and manufactured by Epson to deliver versatile printing, while maintaining consistent quality.

With a 6-colour ink set CMYKOG, plus optional white ink the SurePress L-4733A/AW offers consistent colour reproduction and precise colour matching. It allows label producers to meet the ever-changing creative needs, through high quality and dependable performance on a wide range of substrates.

New ink, additional print modes and greater automation

The enhanced water-based inks with improved wettability offer substrate and application flexibility, together with faster print modes, and greater automation, this ensures higher productivity and repeatable print quality.



Liquors



Novelty



Pharmaceutical



Cosmetics



Industrial
Products



Food and
Beverages



Household
Products



Window
Graphics/POP

Small text is clearly legible



Accurate colour with excellent image quality

Character edges are straight and sharp

Accurate colour printing, every time

Print quality is always consistent across a wide range of substrates.

From printheads to ink, Epson designs and controls all technology inside the Surepress L-4733. This ensures precise colour and exceptional print results again and again.



Variable sized droplet technology

Printing with larger sized droplets delivers solid vibrant colours, whilst the combination of smaller sized droplets and the edge smoothing function provides crisp lines for fine text and barcodes.

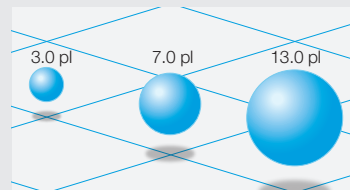

Variable sized droplet technology

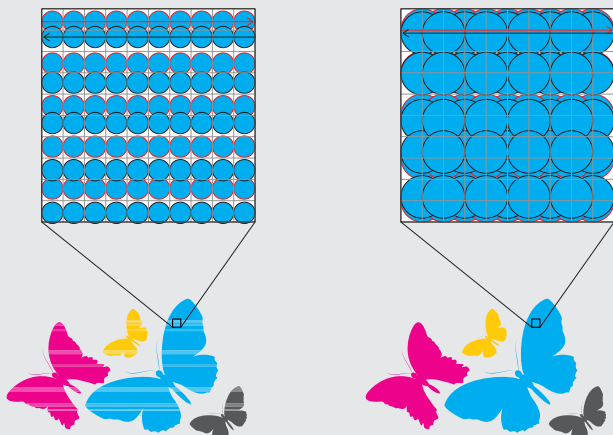

Printing with larger droplets provides solid vibrant colours.

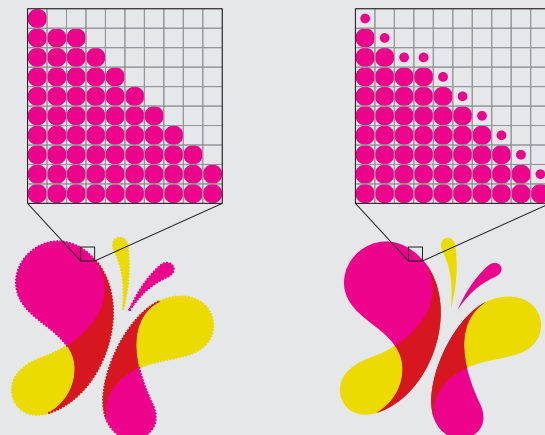

Use edge smoothing function for sharp text and crisp lines

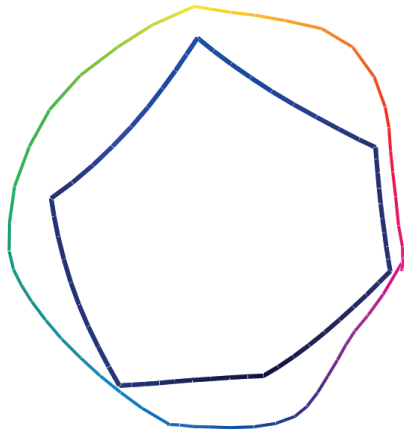

Blue wire: FOGRA39
 Colour wire: SurePress L-4733 AQ T4 inks

Expanded colour gamut

Epson AQ T4 inks are renowned for their wide colour gamut and accurate colour reproduction. The green and orange inks together with cyan, magenta, yellow and black expand the colour gamut for even greater colour accuracy and saturation.



Six colours including green and orange for an extra-wide colour gamut, plus optional white ink.

Pantone® Certification: Up to 96%
 Pantone® Coverage*

The new opaque AQ T4 white ink

The new opaque AQ T4 white ink, can be printed on top or underneath colours and expand the range of applications to meet customers needs.

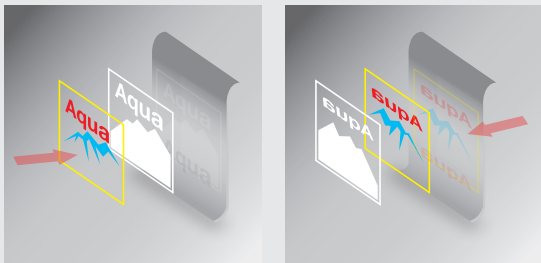

The SurePress L-4733A/AW provides the flexibility of printing white first or last



Printing with confidence

The SurePress L-4733 means short run label printing is more efficient, productive and even simpler than ever.

Stable and easy to use, the SurePress L-4733 makes consistency a priority. Automated maintenance features enable presses to keep working longer and reliably with minimal downtime. The SurePress 4000 series is widely recognised for delivering high levels of quality and consistency and is unique in using water-based ink that can print on both paper and film substrates.



Streamlined production

With many years of experience in labelling technology, research and development, Epson is perfectly placed to fill the needs of all customers. Whether they're dedicated label converters or small manufacturers looking to bring labelling in house, Epson products are designed to add efficiency and reduce cost and waste, without compromising quality.

Automated maintenance

Newly automated maintenance features further reduce unnecessary downtime to achieve higher productivity and dependable performance, on this easy to operate steadfast label press.

Epson AQ4 inks

Epson manufactures its own inks and can control every aspect of the production. With significant investment in systems and hygienic control processes, Epson also applies Good Manufacturing Practices. The SurePress AQ T4 inks comply with European Food Contact material regulations for food packaging. This makes them suitable for a wide range of labelling applications including food, beverage, industrial, cosmetic, toiletries and pharmaceuticals.

Epson Support

Epson label presses are dependable, efficient, and easy to operate. If help is required our worldwide local service technicians are ready to support.

The operational status of the SurePress is monitored using a remote server, allowing real-time, quick response. All done in advance of an on-site visit by our service technicians.

Epson provides full operator training on press and Digital Front End

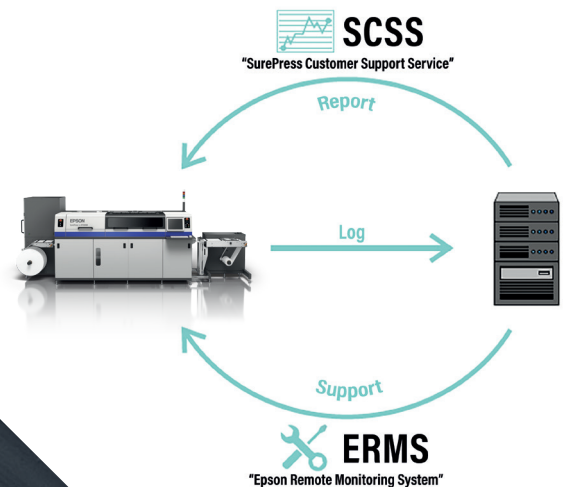

Specifications

Model	SurePress L-4733A/AW
Print technology	Epson MicroPiezo inkjet technology
Resolution	up to 720 x 1440 dpi
Ink type	SurePress AQ T4 Ink (water-based pigmented inks)
Ink cartridge	Black, Uncoated Black, Cyan, Magenta, Yellow, Orange, Green, Over print liquid, Moisture liquid (AW model only: White, Storage liquid)
Image size	315.2 mm x 914.4 mm
Print speed	Up to 8.2 meter per minute
Substrate thickness	80 to 320 µm
Substrate width	80 to 334 mm adjustable to support any width in this range
Substate support	Standard self adhesive label substrate, Semi-gloss, gloss and matte paper stock, BOPP, PET, Yupo and pre-laminated film
Unwinder capacity (Max.)	100 kg weight / 1,000 m length, 600 mm diameter with 76 mm (3") inner core
Dimensions of Press and Rewinder (WxDxH)	5,100 mm x 1,910 mm x 2,020 mm
Weight of Press	Approximately 1,870 kg including rewinder
Network connectivity	Ethernet 1000 base-T or higher is recommended
Power requirements	Input voltage range: Rated voltage ±10% (180 - 220V) Rated voltage: AC (3 phases 3 lines) 200V
Temperature (Operating)	18 - 28 °C
Relative Humidity (Operating)	35 - 55 % (no condensation)
Max. sound level (Operating)	75 dB or less (excluding the alarm sound)

Variable data printing (VDP) licencing optional.

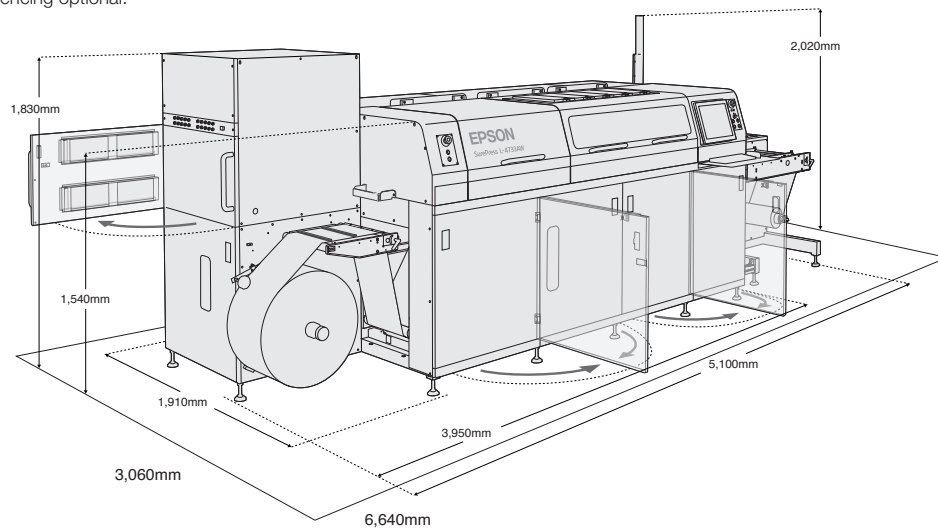

A14100_SurePress_L-4733_1EN-INT_08/22

*The Epson SurePress L-4733A/L-4733AW printer has been evaluated and approved by Pantone as being capable of achieving 96% of the PANTONE® Solid Formula Guide Coated Publication on the AVERY PRIMAX 250TC/S692N/BG40W BW6033B1 substrate and Epson ink. 96% calculated using CIEDE2000 <=1.5 tolerance.

PANTONE® and other Pantone trademarks are trademarks or registered trademarks of Pantone LLC in the United States and/or other countries. PANTONE trademarks used under License Agreement between Pantone LLC and Seiko Epson Corporation. All rights reserved.

* Warranty offers are not available for all countries. Please contact your local Epson representative.

For further information please contact your local Epson office or visit www.epson.eu/contact-us

Algeria +213 770 938 617 Austria 01 253 49 78 333 Belgium +32 (0)2 792 04 47 Czech +420 246 037 281 Denmark 44 50 85 85 Ethiopia +254700760366 Finland 0201 552 091 France 09 74 75 04 04 (Cost of local call, operator charges may apply) Germany +49 (0) 2159/92 79 500 Greece (0030) 211 198 62 12 Hungary 06800 147 83 Ireland 01 436 7742 Israel (+972)-3-5751833 Italy 02-660321 10 (0.12 €/min) Kenya +254 207 904 566 Luxembourg +352 27860692 Middle East +9714 2677638 Morocco +212 520 134 040 Netherlands +31 (0)20 708 5099 Norway +47 67 11 37 00 Poland +48 22 295 37 25 (0.16 zł/min) Portugal 707 222 111 Romania 0040 214025024 Russia (095) 777-03-55 Slovakia +421 232 786 682 Southern Africa +27 (0) 10 109 5320 Spain 93 582 15 00 Sweden +46 8 5051 3701 (Mobilsamtal – 0,99 kr/min, Lokala samtal – 0,30 kr/min, Utlandssamtal – 0,89 kr/min) Switzerland 022 592 7923 Tanzania +255 080 011 1014 Tunisia +216 9811 5564 Turkey (0212) 3360303 Uganda +256 205 491 148 United Kingdom 0871 42 37766 (+10p per minute plus network extras) West Africa +2349046648285

Trademarks and registered trademarks are the property of Seiko Epson Corporation or their respective owners. Product information is subject to change without prior notice.

EPSON®